

THE ORIGINAL ELECTRONIC
TAPE DISPENSER

zCM•1000

zCM•1100

zCM•2000

zCM•2200

RESOURCE GUIDE

Product Manual

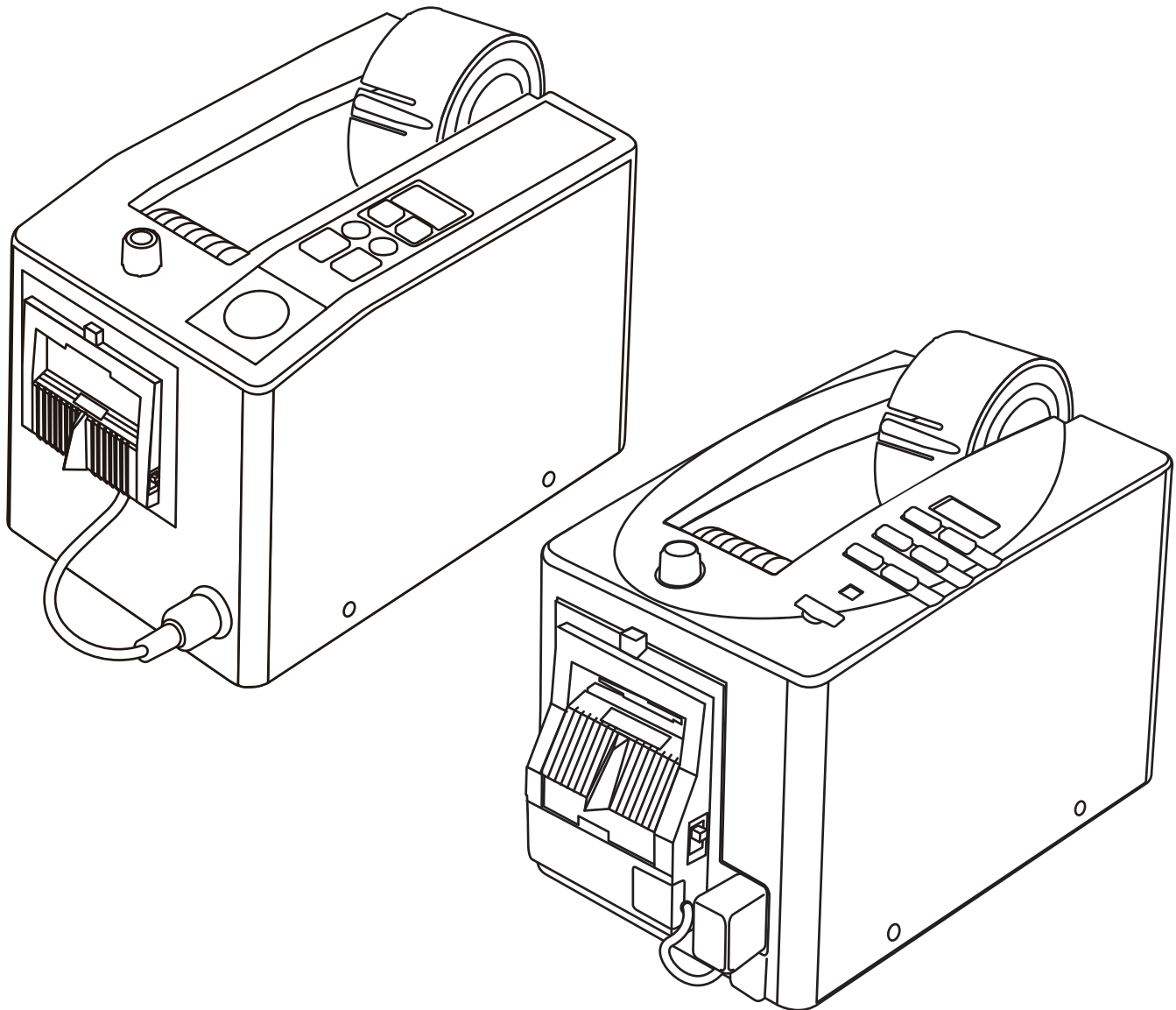

 **START**[®]
International

The information contained in this Resource Guide along with additional maintenance and repair information, videos and photos can be found online at www.STARTInternational.com

© START International

Contents

1 Notice	1.1 Product Comparison	1
	1.2 ⚠ Warning	2
	1.3 ⚠ Caution	2
2 Description of Parts & Functions	2.1 For zcM1000 / zcM2000	3
	2.2 For zcM1100 / zcM2200	4
3 Operation	3.1 Setting up.	5
	3.2 Loading tape.	5
	3.3 Setting tape length	6
	3.4 Resetting saved length	6
	3.5 Using automatic feed	7
	3.6 Using manual feed	7
	3.7 Safety shutter (Safety device) 1100 2200	7
	3.8 How to release "Err" " - - - " error 1100 2200	7
	3.9 Changing tape	8
	3.10 How to remove jammed tape	8
	3.11 Length memory function 1100 2200	9
	3.12 Changing saved preset lengths	10
4 Maintenance	4.1 Replacing separating roller unit	11
	4.2 Maintenance of cutter blades	11
	4.3 Replacing cutter and cutter liner	12
	4.4 Replacing fuse	13
5 Specifications		13

1 Notice

This instruction manual is for START International Tape Dispensers, models No.: zcM1000, zcM2000, zcM1100 and zcM2200.

Refer to the following comparison chart for model differences:

1.1 Product Comparison

Model No.	zcM1000	zcM2000	zcM1100	zcM2200
Automatic feed and cut	●	●	●	●
3 Length memory	—	●	—	●
Safety cutter	—	—	●	●

Refer to page 9 for details of length memory. **2000 2200**

Refer to page 7 for details of safety shutter. **1100 2200**

1.2 ⚠ Warning

Do NOT insert your fingers into cutting head.

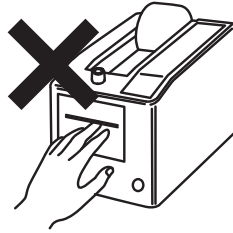

1.3 ⚠ Caution

Do NOT place anything flammable in or on the unit.

Do NOT use the unit on an unsteady surface.

Do NOT use the unit in humid or dusty environment.

Do NOT disassemble or modify the tape dispenser.

Make sure to unplug the unit when moving it or replacing parts.

Do NOT insert bars or plates into the tape outlet. This will damage blades.

Do NOT drop the unit or subject it to heavy shocks.

Do NOT use volatile liquids (thinner, benzene, etc.) to clean the unit. Wipe with dry cloths only.

Do NOT use damaged cable. This may cause a fire or electric failure.

Do NOT use the unit near volatile liquid.

Do NOT use power other than the set voltage labeled on the machine. (110-117V or 220 – 240V)

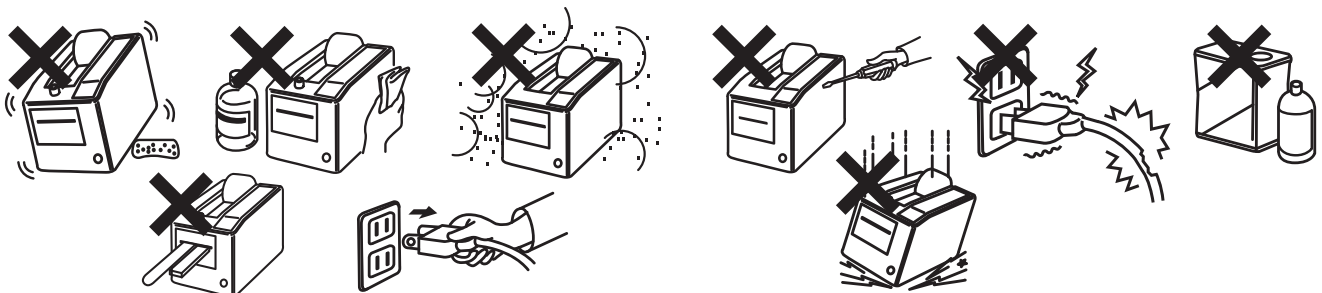

2 Description of Control Panel Functions

2.1 For zcM1000 / zcM2000

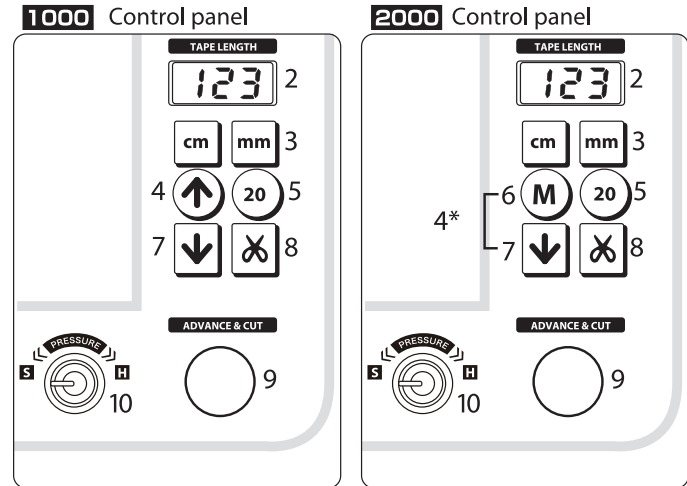
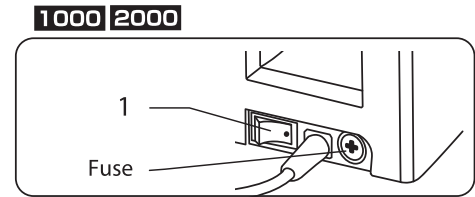
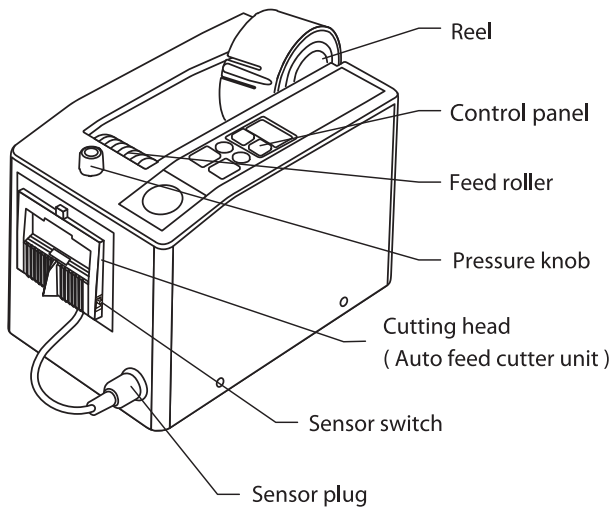

1 Power switch	Press to turn power ON or OFF.
2 Tape length display	Shows tape length and errors.
3 Length adjustment key	The last digit indicates "mm" (0 - 9mm) and the first two digits "cm" (20 - 990mm).
4 Reverse key	<p>1000 Feed roller reverses by pressing . Use this key for changing tape.</p> <p>-----</p> <p>2000 Feed roller reverses by pressing M + . Use this key for changing tape.</p>
5 20(reset)key	Resets length display reset and back to min set length of 20mm.
6 Memory key	2000 Press and hold until the LED display flashes to save memory. Saved lengths are selected by short pressing of this key.
7 Feed key	Tape dispenses as long as is pressed.
8 Cut key	Press to cut tape.
9 Auto Key	Press AUTO to feed tape to the preset length and cuts automatically.
10 Pressure knob	Adjusts (top) roller to change pressure on tape.

2.2 For zcM1100 / zcM2200

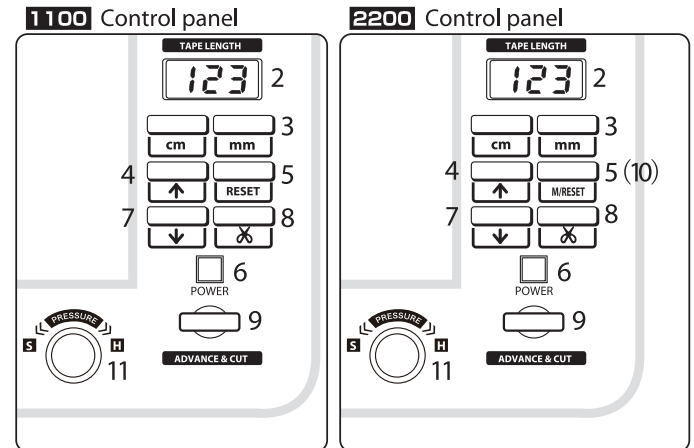
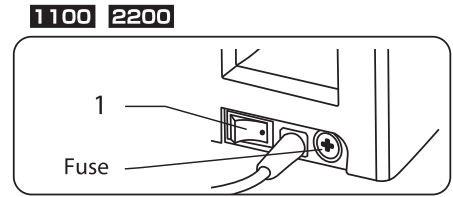
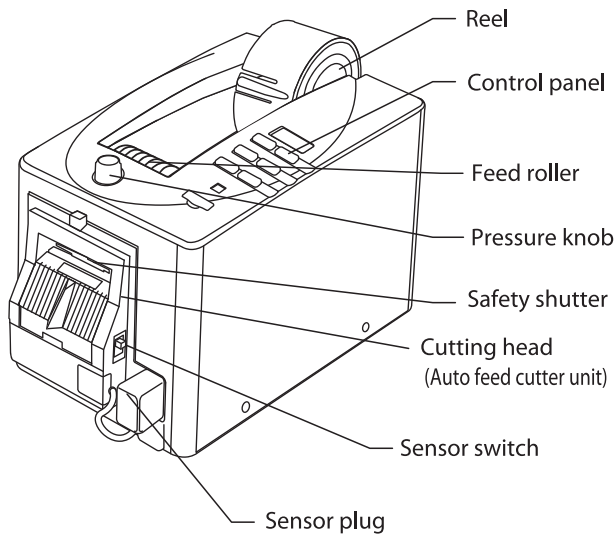

1 Power switch	Press to turn power ON or OFF
2 Tape length display	Shows tape length and errors.
3 Length adjustment key	The last digit indicates "mm" (0-9mm) and the first two digits "cm" (30 – 990mm). mm + cm : Back to min set length of 30mm
4 Reverse key	Feed roller reverses by pressing . Use this key for changing tape.
5 Reset key (M/RESET for 2200)	RESET Clear error by pressing this key twice.
6 Power LED	<input type="checkbox"/> Lamp is lit when the power is turned ON.
7 Feed key	Tape dispenses as long as is pressed.
8 Cut key	Press to cut tape.
9 Auto Key	Press AUTO to feed tape to the preset length and cuts automatically.
10 Memory key	2200 M/RESET Press and hold until the LED display flashes to save memory. Saved lengths can be checked by short presses of this key.
11 Pressure knob	Adjusts (top) roller to change pressure on tape.

3 Operation

3.1 Setting up

 <p>Attention</p>	Make sure power and sensor switches are OFF to ensure safety
--	--

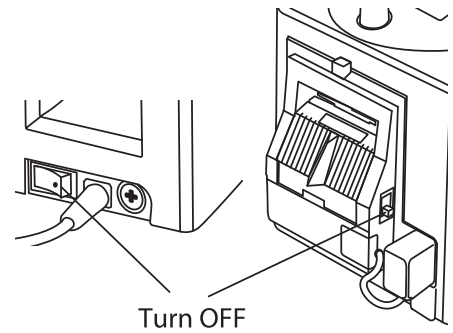

- ① Plug sensor plug into the unit.
- ② Plug power cord in.
- ③ Turn the power switch ON.

1000 2000

Min set length of 20 will be shown on the LED display.

LED display



1100 2200

Min set length of 30 will be shown on the LED display.

LED display



3.2 Loading tape

- ① Remove the reel from the unit.
Load tape on the reel and place it back in the unit.
- ② Make sure to position the tape on the center of the reel.
- ③ Fold corners of the tape to form a trapezoid shape (Fig.). Stick the tape onto metal feed roller.
- ④ Press "↓" until tape feeds through cutting head.

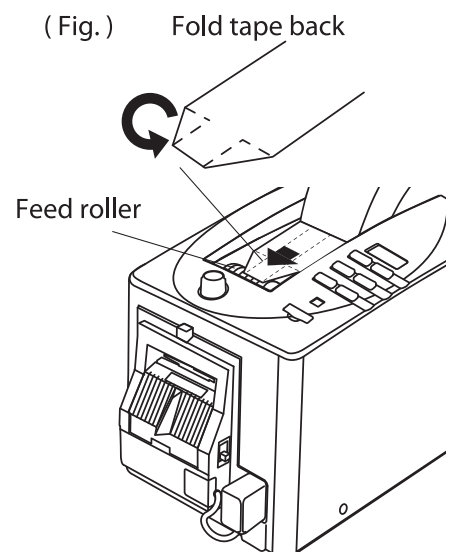

- ⑤ Adjust "Pressure knob" in accordance with tape.
- If tape curls up or slips, increase pressure. (Turn Clockwise)
 - If tape creases, decrease pressure. (Turn Counter-clockwise)



- ⑥ Advance 3cm – 4cm of the tape out from the cutting head.

- ⑦ Press "✂" to cut the tape.

- ⑧ Remove tape

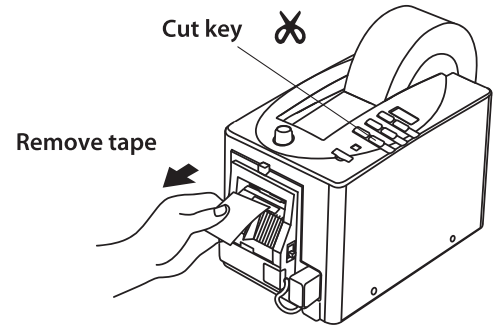

3.3 Setting tape length

Make sure sensor switch is OFF.

Press "mm" and "cm" for setting length.

- ① Press "mm" to set length of 0-9mm(Last digit)
- ② Press "cm" to set length of **1000 2000** 20 -990mm / **1100 2200** 30 -990mm.(First two digits)

* Keep pressing button for quick change.

* Last setting length is saved even when main power is turned OFF.

LED display



3.4 Resetting saved length

1000 2000 Press "20" to reset and back to min set length of 20mm.



1100 2200 Press "mm + cm" to reset and back to min set length of 30mm.

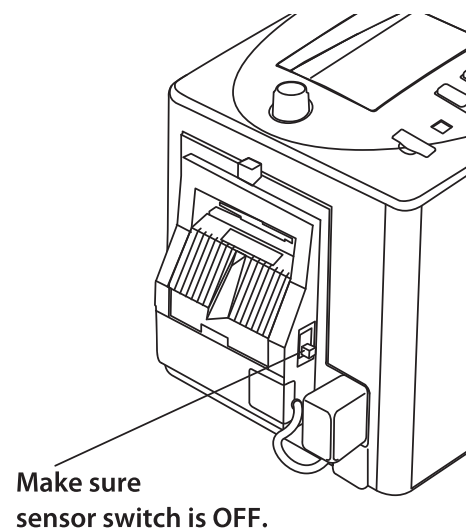

3.5 Using automatic feed

- ① Turn sensor switch located on cutting head to ON.
- ② Tape will be fed at a set length and cut.
- ③ Remove a piece of tape from machine.
- ④ Another piece will be fed and cut.

Remove a piece of tape

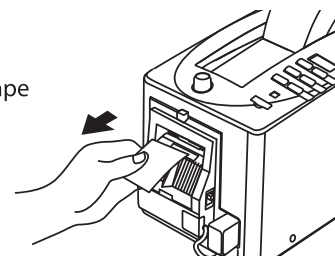

Automatically set length is fed and cut

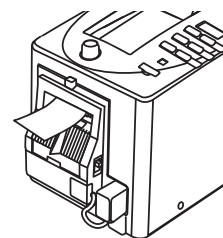

3.6 Using manual feed

- ① Turn sensor switch OFF.
- ② Press **"ADVANCE & CUT" 1000** or **"AUTO" 2000 1100 2200**
- ③ Whenever **"ADVANCE & CUT/AUTO"** is pressed, set length is fed and cut.

Press "Advance & Cut" or "Auto" key

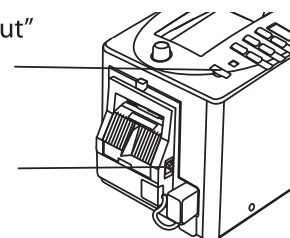

Turn sensor switch OFF.

3.7 Safety shutter (Safety device) 1100 2200

The Safety Shutter System prevents activation of cutter when foreign objects are present.

- When safety device is activated, error (Err) is shown on the LED display.
- " - - - " error will be shown, if any keys are pressed while display shows "Err" error.
- No safety shutter for **1000** and **2000** .

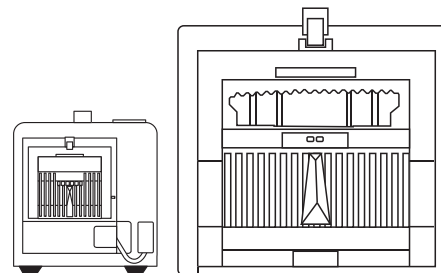

safety shutter activated

3.8 How to release "Err" " - - - " error 1100 2200

- ① Remove cutting head from the unit.
- ② Remove jammed tape.
- ③ Move shutter and cutter by tool and back them to the right position(Fig.).
- ④ Press **" RESET" (1st press)**
- ⑤ LED display shows length.
- ⑥ Press **" RESET" again. (2nd press)**
- ⑦ Error will be released.
 - Ask distributor or START International if error cannot be cleared.

(Fig.)

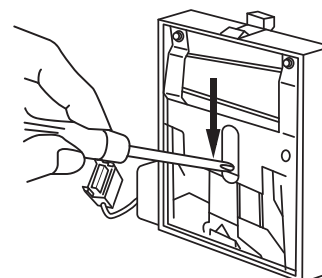

3.9 Changing tape

① Turn sensor switch OFF.

② Press “↑” to reverse tape.

2000 “M” + “↓”

The feed roller will rewind the tape away from cutter area.

③ Remove whole reel from the unit and replace tape.

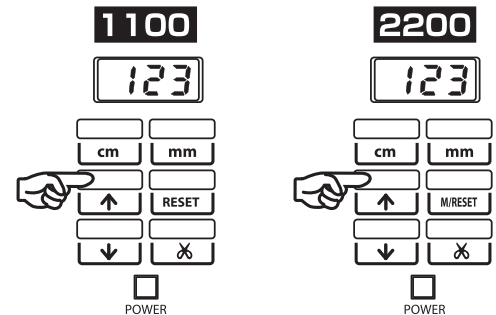
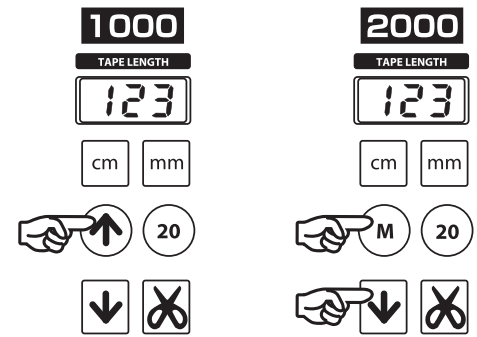

3.10 How to remove jammed tape

① Press “↑” to reverse tape.

“M” + “↓” for reverse. **2000**

- Hold the tape and wind it backward slightly as per (Fig.).

② Remove tape from metal roller.

③ Cut wrinkled part of tape.

● In case of heavy tape jam.

① Remove cutting head from the unit.

② Cut wrinkled part of tape.

③ Remove jammed tape with tweezers.

- Cut any tape wrapped around rollers with scissors. Take care to avoid damaging rollers.

● If tape is jammed in the cutting head.

① Remove cutting head from the unit.

② Check the gap of the blade on the back.

③ Remove jammed tape with tweezers.

- If heavily jammed, cutter spring needs to be removed. See page 12 for details.

(Fig.) Wind the tape backward slightly

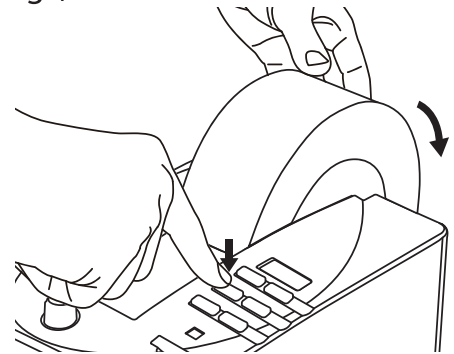



Attention

Make sure sensor switch is OFF to ensure safety.

3.11 Length memory function **2000 2200**

Set preset lengths and select a mode.

3 different lengths can be saved, and 2 different modes are selectable.

Preset mode (on " 0 ")

On " 0 ", the machine will feed and cut the first set length until the

" M " is pressed, then it will feed the second length until

the " M " is pressed, and so on.

LED display



Loop mode (on " 5 ")

On " 5 ", the machine will feed and cut the recorded length in series.

LED display



STEP.1 Save lengths

2000 Press and hold "M" (" " for **2200**) until the LED display starts flashing.

- Flashing LED display = Setting mode

Press and hold



1st preset length (Memory 1)

Press " mm " , " cm " and set the desired length for **memory 1**.

2000 Press " M " (for **2200**) to record length for **memory 1**.

Recorded Length 1

e.g. length 50mm



2nd preset length (Memory 2)

Press " mm " , " cm " and set the desired length for **memory 2**.

2000 Press " M " (for **2200**) to record length for **memory 2**.

- If 2nd preset length is not needed, leave " 999 " and

2000 press " M " (for **2200**).

Recorded Length 2

e.g. length 100mm



3rd preset length (Memory 3)

Recorded Length 3 e.g. length 300mm

Press " mm " , " cm " and set the desired length for **memory 3**.

- If 3rd preset length is not needed, leave " 999 " .



2000 Press " M " ( for **2200**) to save **all programmed lengths**.

Then "0" will be shown on the LED display.



STEP 2 Mode Selection

Preset Mode : On " 0 "

2000 Press and hold " M " ("  " for **2200**)

Press and hold 

until the LED display **stops flashing**.

1st preset length will be shown.



Loop Mode : On " 5 "

Press " mm " .



And " 0 " will be turned to " 5 " .



2000 Press and hold " M " ("  " for **2200**)

Press and hold 

until the LED display **stops flashing**.

1st preset length will be shown.



"Preset Mode" settings are complete.

"Loop Mode" settings are complete.

3.12 Changing saved preset lengths

- Change all

2000 Press " 20 " to reset all settings.





- 2200** 1. Turn the main power OFF.
2. Turn the main power ON while keep pressing "  " resets all settings.



 Press and hold

OFF ON  turn on

- Change preset length **memory 1 and memory 2** **2000** **2200**

- 2000** Press and hold " M " ("  " for **2200**) until the LED display **starts flashing**.
- 2000** Press " M " ("  " for **2200**) to choose length preset you'd like to change.
- Press " mm " " cm " keys to change length.
- 2000** Press and hold " M " ("  " for **2200**) until the LED display **stops flashing**. 1st preset length will be shown and complete changing preset length.

4 Maintenance

 Caution	For safety reasons, make sure to unplug power cord from power outlet before any maintenance.
 Caution	Do NOT touch cutter/blade!

4.1 Replacing separating roller unit

Rubber rings on "Separating roller unit" are consumable parts. (ZCM1000P138 or ZCM1000P138-1)
Regular replacement is required to maintain satisfactory feeding operation.

- ① Remove cutting head.
- ② Unscrew ① and ② .
- ③ Pinch centre of separating roller unit and pull it out. (ZCM1000P533 or ZCM1000P533-1)
- ④ Replace with new unit.

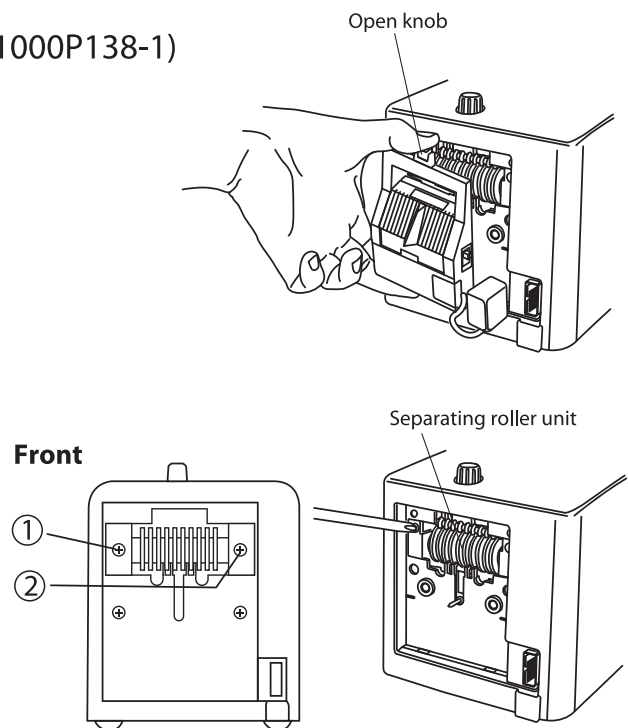

4.2 Maintenance of cutter blades

Although a special coating is applied to the cutter/blade, adhesive will build up eventually.

In order to maintain satisfactory feeding operation, remove accumulated adhesive regularly. Use alcohol for removal.

Then use enclosed "silicone oil" to minimize glue adhesive up.

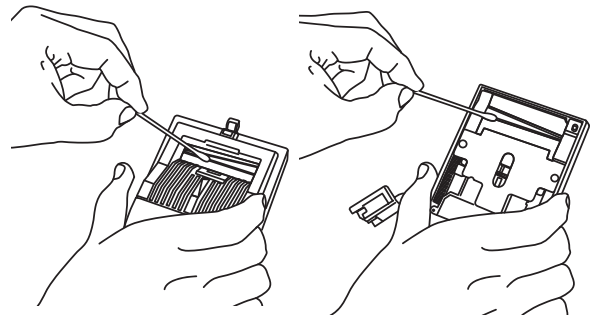



Caution

Pay extra attention when replacing cutter/blade!

4.3 Replacing cutter/blade and cutter liner

Cutter and cutter liner are consumable parts.

Regular replacement of cutting head, cutter blades, and individual liners are required to maintain satisfactory cutting operation.

- ① Remove cutting head.
- ② Turn 2 screws and remove cutter spring.



Attention

Hold cutter spring in place when unscrewing to prevent injuries due to loose parts.

- ③ Remove cutter/blade.
- ④ Note the direction of the cutter/blade and replace cutter liners if necessary.

⑤ Replace cutter/blade.

⑥ Place cutter spring back into assembly.

⑦ Secure cutter spring by tightening the 2 screws.

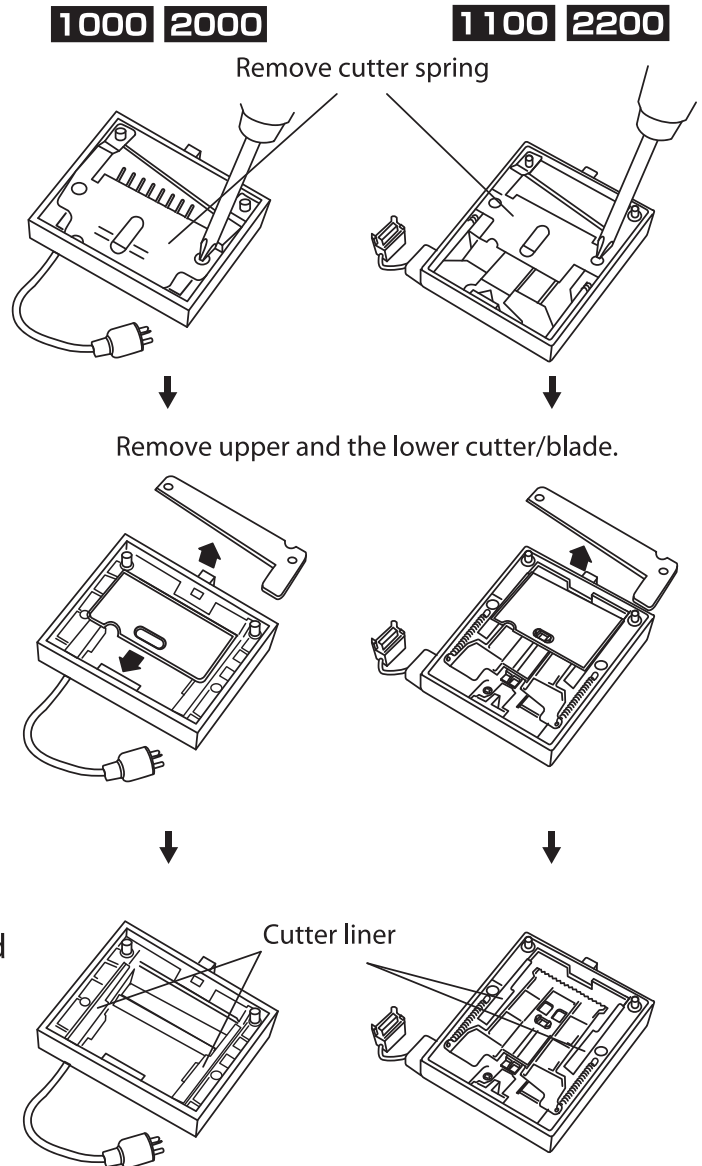

Make sure to position the cutter/blade in the proper direction.

Cutter/Blade

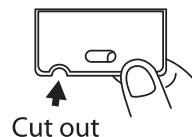

Cutter/Blade

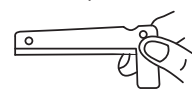

4.4 Replacing fuse

- ① Turn main power OFF and unplug power cord.
- ② Turn fuse holder lid to counter clockwise with Phillips screwdriver.
- ③ Replace fuse.
- ④ Put fuse holder lid back and tighten by turning clockwise with screw driver.

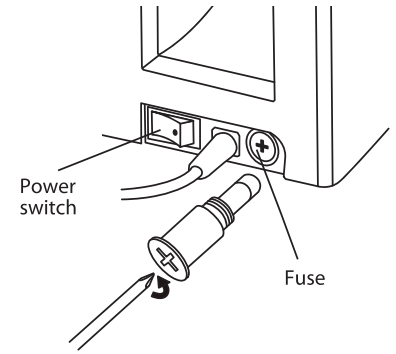

5 Specifications

Model No.	zcM1000	zcM2000	zcM1100	zcM2200
Display	3 digit LED			
Applicable Tape Width	7 - 50mm (.28" - 2") * "Magnetic Tape Guide" as an option is suggested for 7 - 30mm width tape. (ZCM1000P024)			
Cut Length	20 - 999mm (.78" - 39")		30 - 999mm (1.2" - 39")	
Core (Reel) Diameter	3-in-1 reel (25mm, 35mm, 76mm) (1", 1.4", 3")			
Max Outside Dia. of Tape	φ170mm (Larger reel stand is available as an optional part) (ZCM1000P026)			
Usable Tapes	Cellophane, Kraft, Cloth, PP, Double-sided, Filament, Creped, etc. * Machine may experience difficulty feeding or cutting tapes with the following characteristics: curling, strong adhesive, black color, high transparency, extremely thin, slippery, static generating and other uncommon characteristics.			
Drive	DC motor for tape feeding and cutting			
Power Consumption	18W			
Power (AC)	110 - 117V 50/60Hz or 220 - 240V 50 / 60Hz			
Ambient Light	Fluorescent: 3,000 lx or less (About 30cm under 40W) Incandescent: 800 lx or less (About 45cm under 60W) Sunlight: 10,000 lx or less (Do not operate in direct sunlight)			
Ambient Temp & Humidity	5°C - 40°C, 80% Humidity or less			
Size (W x L x H)	137×245×156mm	137×245×156mm	137×249×156mm	137×249×156mm
Weight	About 2.4kg (5.3 lbs)		About 2.5kg (5.5 lbs)	
Cabinet Material	ABS V-O		ABS plastic	

* Accuracy of cut is about ±2mm (depending on tape).

* Specifications are subject to change without notice.



START International

4270 Airborn Dr. Addison, TX 75001, U.S.A.

Tel 972.248.1999 Fax 972.249.1991

service@STARTinternational.com

www.STARTinternational.com