

AUTOMATIC WEBBING CUTTER

TBC-50LH

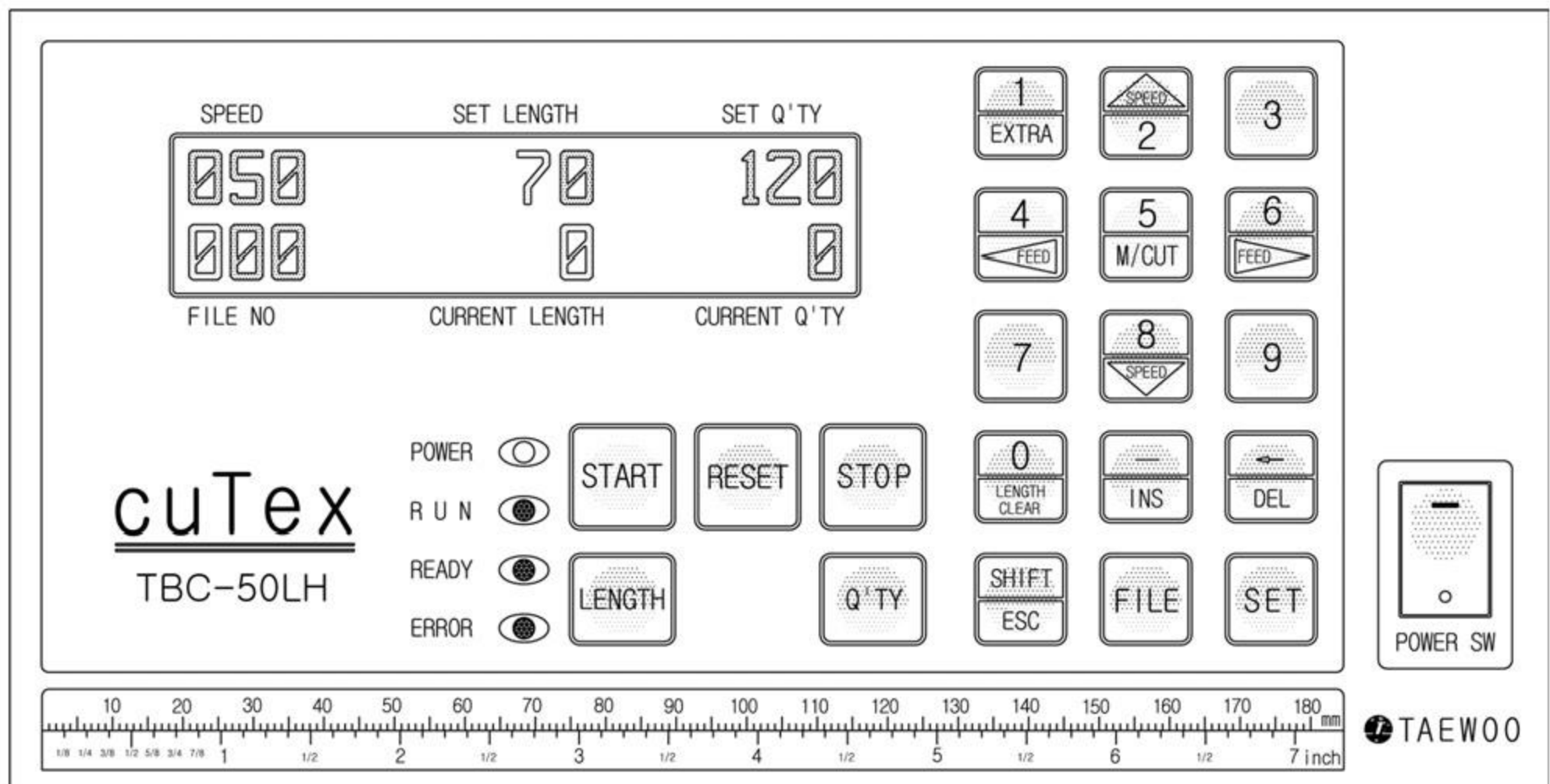

How to operate TBC-50LH



1. An example (Cutting length : 70mm, Cutting quantity : 120 pcs)

▷ Turn on the POWER SW.

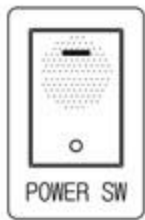

▷ Set the temperature. (It is normally used at 250°~350°C. About 5 minutes after turn-on, it will be reached to set-temperature with the red LED turned off automatically.)

※ **Caution** : When a work is over, set the temperature at zero and turn the cooling fan 10 minutes or so and power off.

▷ Set cutting length. (Press the following buttons in order.)

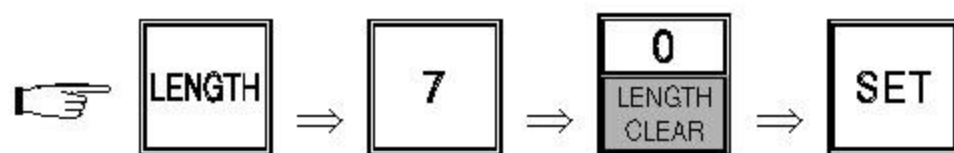

▷ Set cutting quantity.



▷ Press START button.



2. Key functions

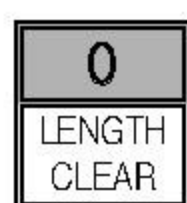

: Current length on display will be back to "0" at a stop.



: All of current length and current q'ty on display will be back to "0".

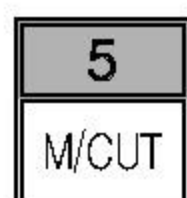

: Moving knife only.

- ① to cut the material for test.
- ② to take out the material jammed between knife blades.
- ③ for balancing of knife blades in exchange.



: Cutting additional one.

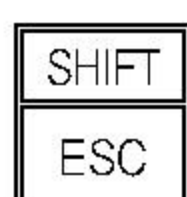

: Restoring to normal condition in ERROR(red LED) and inputting parameter or program.



: to move the roller manually for mounting the material on the machine or for feeding it forwards or backwards.



— Speed up (The current speed appears on the left-upside of LCD display with "%". Normal speed : 50%, Maximum speed : 100%)

* Speed up & down is possible in any time(operation or stop) and set-speed will not be changed even though you press RESET button or power off & on.



— Speed up (The current speed appears on the left-upside of LCD display with "%". Normal speed : 50%, Maximum speed : 0%)

* Speed up & down is possible in any time(operation or stop) and set-speed will not be changed even though you press RESET button or power off & on.



: to correct wrong data.



: Function for label cutting (applicable models : TBC-50S, TBC-50SH)

3. Specification

Model No.	Cutting Material	Knife	Power Supply	Max. Cutting Width	Range of Cutting Length	Cutting speed (length : 1M)	Machine Size (Net Weight)	Packing Size (Gross Weight)
TBC-50LH (Webbing Cutter)	Webbing, Seat Belt	Hot	AC110/220V, 50/60Hz	200mm	30mm~300M	18~30 cuts	510×690×940 (85kgs)	830×560×770 (89kg)

4. Caution for use

- Before use, please confirm the voltage and make the ground(earth) connection.
- **In case of cutting double or triple rolls at the same time, make materials fed oppositely(↶ & ↷), to prevent slipping by roll tension.**
- Do not access hands or any object close to the working knife. (for safety)
- When the knife blade becomes dull, please use it after grinding with the grinding machine. (Please do not let the unskilled person grind manually or install the knife blade.)
- Please contact following address for further information.

TBC-50LH Part Drawing A

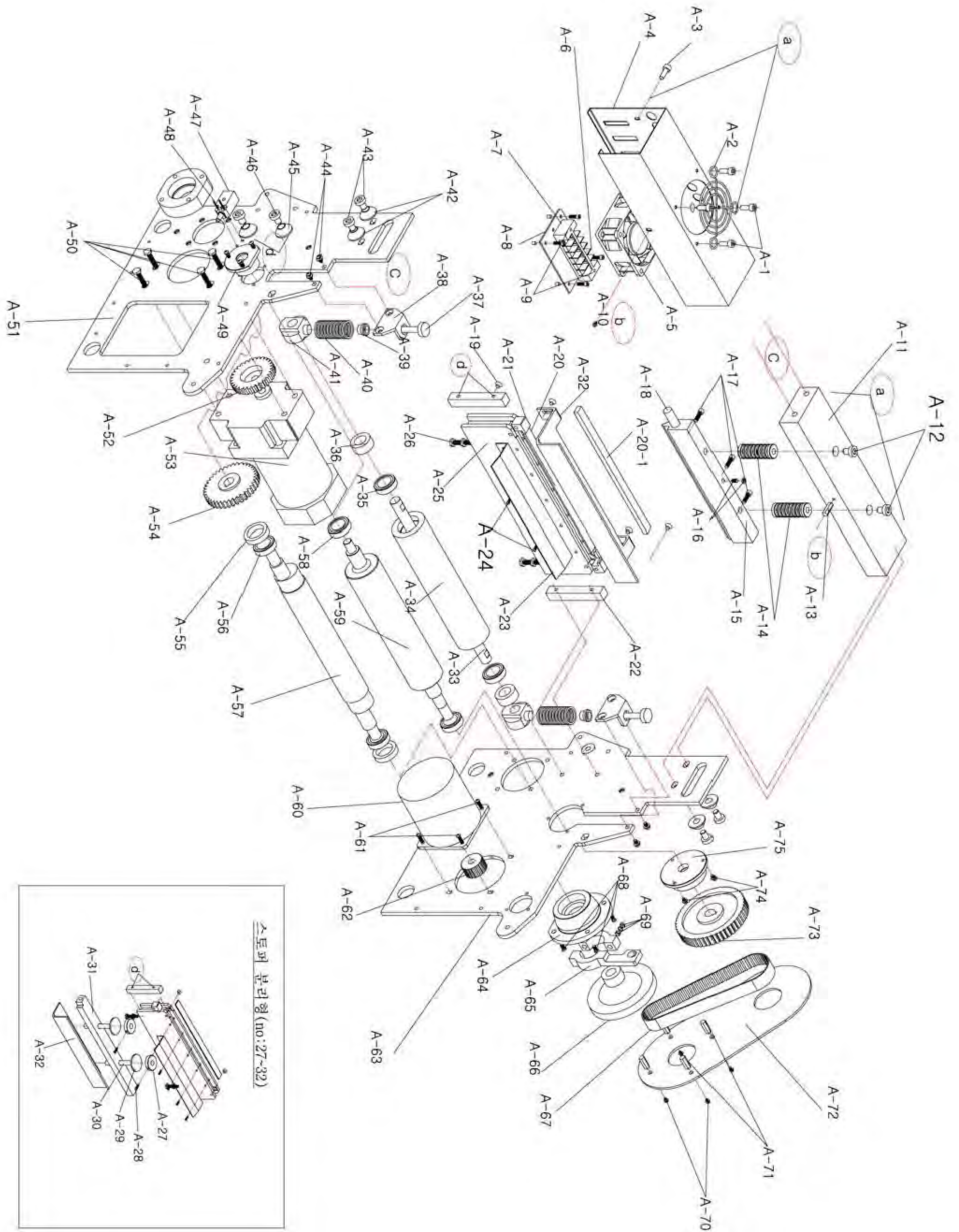

TBC-50LH Part List A

PART NO.	DESCRIPTION	PART NO.	DESCRIPTION
A-1	ROUND HEADED BOLT(M3)	A-38	ROLLER TENSION BRACKET
A-2	COOLING FAN SAFETY COVER	A-39	PRESSURE CONTROL SPRING COVER
A-3	ROUND HEADED BOLT(M4×6 STAINLESS)	A-40	ROLLER PRESSURE CONTROL SPRING
A-4	UPPER KNIFE COVER	A-41	UPPPER ROLLER GUIDE BLOCK
A-5	COOLING FAN	A-42	CLAMPING NECK WASHER
A-6	6P TERMINAL	A-43	WRENCH BOLT(M8)
A-7	TERMINAL HEAT PLATE	A-44	ROUND HEADED BOLT(M6)
A-8	HEAT PLATE SUPPORT	A-45	CLAMPING NECK WASHER
A-9	CLAMPING BOLT(M5)	A-46	FLAT HEAD BOLT(M6)
A-10	ROUND HEADED BOLT(M5 STAINLESS)	A-47	COUNTING SENSOR
A-11	UPPER KNIFE MAIN FRAME	A-48	ECCENTRIC AXLE BEARING HOUSING(R)
A-12	WRENCH BOLT(M8)	A-49	ROLLER BEARING HOUSING(R)
A-13	STAINLESS COVER BRACKET	A-50	CUTTING MOTOR CLAMPING BOLT
A-14	UPPER KNIFE BRACKET	A-51	RIGHT FRAME
A-15	UPPER KNIFE	A-52	SPUR GEAR(S)
A-16	TEMPERATURE SENSOR	A-53	CUTTING MOTOR
A-17	SET SCREW(M6)	A-54	ROLLER TIME GEAR(L)
A-18	HEATER	A-55	COUNTING SENSOR BRACKET
A-19	FLAT HEAD BOLT(M5)	A-56	BEARING(#6007)
A-20	HEATING PRESSURE PLATE	A-57	CRANK SHAFT
A-20-1	SILICONE PAD	A-58	BEARING(#6202)
A-21	PRESSURE PLATE CLAMP	A-59	LOWER ROLLER
A-22	RAM GUIDE	A-60	STEPPING MOTOR
A-23	ROLLER SPACE PLATE	A-61	STEPPING MOTOR CLAMPING BOLT
A-24	ROUND HEADED BOLT(M5)	A-62	ROLLER TIME GEAR(S)
A-25	PRESSURE FRAME	A-63	LEFT FRAME
A-26	PRESSURE FRAME CONTROL BOLT(M6)	A-64	ECCENTRIC AXLE BEARING HOUSING(L)
A-27	STOPPER CONTROL RING SUPPORT	A-65	GEAR BRAKE
A-28	WRENCH BOLT	A-66	SHAFT KNOB
A-29	SILICON WASHER (NOISE CONTROL)	A-67	TIMING BELT(200XL)
A-30	OILLESS	A-68	FLAT HEAD BOLT(M6)
A-31	STOPPER BRACKET	A-69	BRAKE PRESSURE CONTROL NUT(M6)
A-32	STOPPER	A-70	CLAMPING BOLT(M5 STAINLESS)
A-33	UPPER ROLLER SHAFTOLLER	A-71	STEPPING MOTOR CLAMPING NUT
A-34	UPPER ROLLER	A-72	TIMING GEAR(64T×2)
A-35	BEARING(#6002)	A-73	SPUR GEAR(LARGE)
A-36	ACETAL RING SUPPORT	A-74	ROUND HEADED BOLT
A-37	ROLLER PRESSURE CONTROL BOLT	A-75	ROLLER BEARING HOUSING(L)

TBC-50LH Part Drawing B

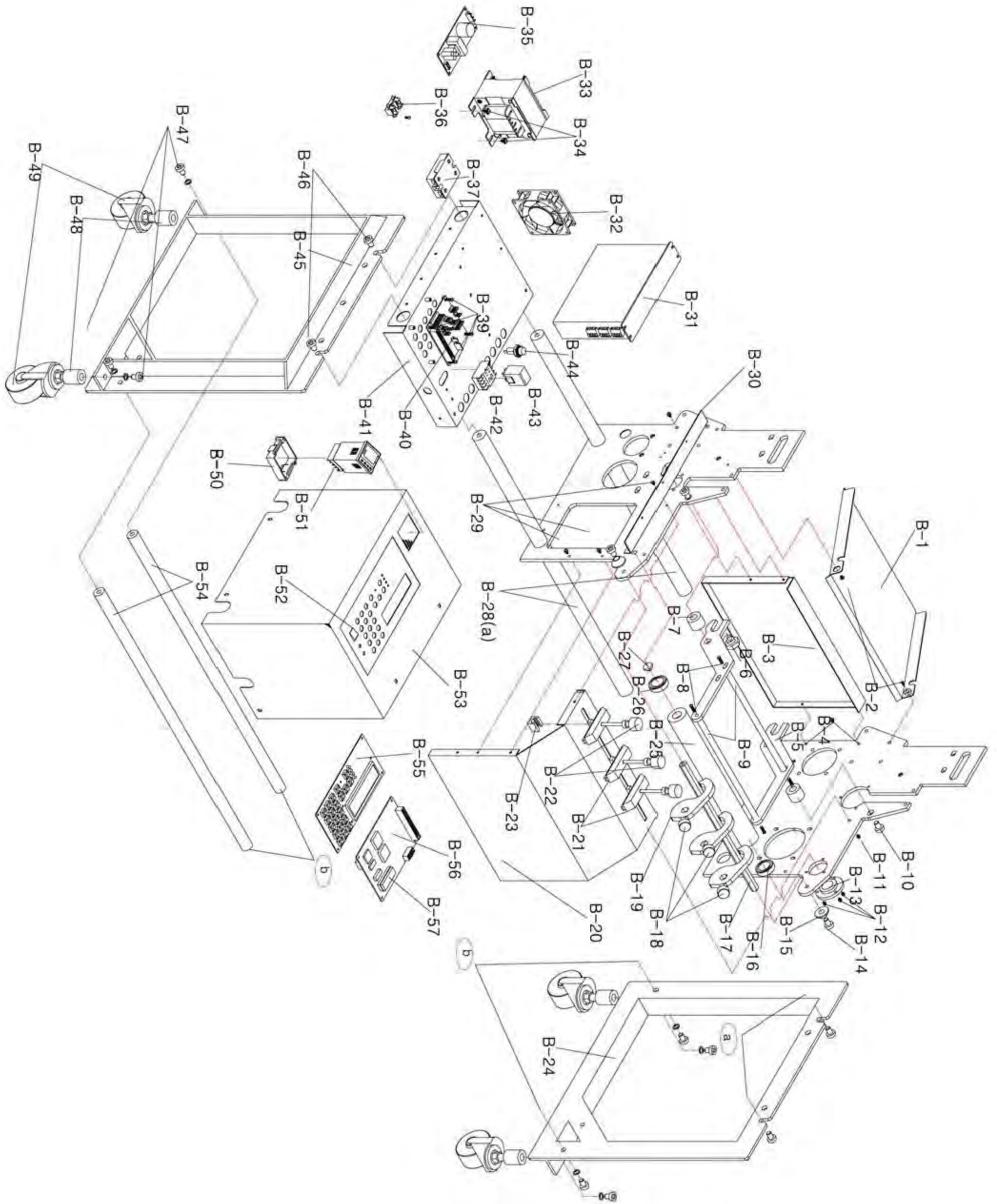

TBC-50LH Part Lists B

PART NO.	DESCRIPTION	PART NO.	DESCRIPTION
B-1	TAPE GUIDE	B-40	DRIVE BOARD(DR)
B-2	ROUND HEADED BOLT(M6)	B-41	CONTROL BASE
B-3	FRONT COVER	B-42	RELAY SOCKET
B-4	ROUND HEADED BOLT(M4)	B-43	RELAY
B-5	LEVER	B-44	FUSE BOX
B-6	LEVER CLAMPING BOLT(M8)	B-45	RIGHT ANGLE FRAME
B-7	LEVER CLAMPING NUT(M8)	B-46	CLAMPING BOLT
B-8	ROUND HEADED BOLT(M6)	B-47	CLAMPING BOLT(M8)
B-9	LEVER SHAFT	B-48	WHEEL CLAMPING NUT
B-10	WRENCH BOLT	B-49	WHEEL
B-11	CLAMPING BOLT(M4)	B-50	TEMPERATURE CONTROLLER SOCKET
B-12	CLAMPING BOLT(M4)	B-51	TEMPERATURE CONTROLLER
B-13	GUIDE ROLLER BEARING HINGE	B-52	SWITCH
B-14	WRENCH BOLT(M6)	B-53	CONTROL CASE
B-15	CLAMPING NECK WASHER	B-54	ANGLE SHAFT
B-16	BEARING(#6001)	B-55	OP BOARD(OP)
B-17	BACK GUIDE HEXAGONAL PIN	B-56	CONTROL BOARD(MB)
B-18	KNOB HANDLE BOLT(M6)	B-57	ROM
B-19	BACK GUIDE		
B-20	BACK COVER		
B-21	GUIDE		
B-22	GUIDE BOLT		
B-23	GUIDE FIXING NUT		
B-24	LEFT ANGLE FRAME		
B-25	GUIDE ROLLER		
B-26	BEARING		
B-27	BEARING HINGE		
B-28	ANGLE SHAFT		
B-29	CLAMPING BOLT(M4)		
B-30	CONTROL SIDE BASE		
B-31	DRIVER(BLACK BOX)		
B-32	COOLING FAN		
B-33	TRANSFORMER		
B-34	CLAMPING BOLT(M50)		
B-35	SMPS(SP)		
B-36	TERMINAL		
B-37	SSR(SOLID STATE RELAY)		
B-39	CLAMPING BOLT		

TBC-50LH REEL HANGER

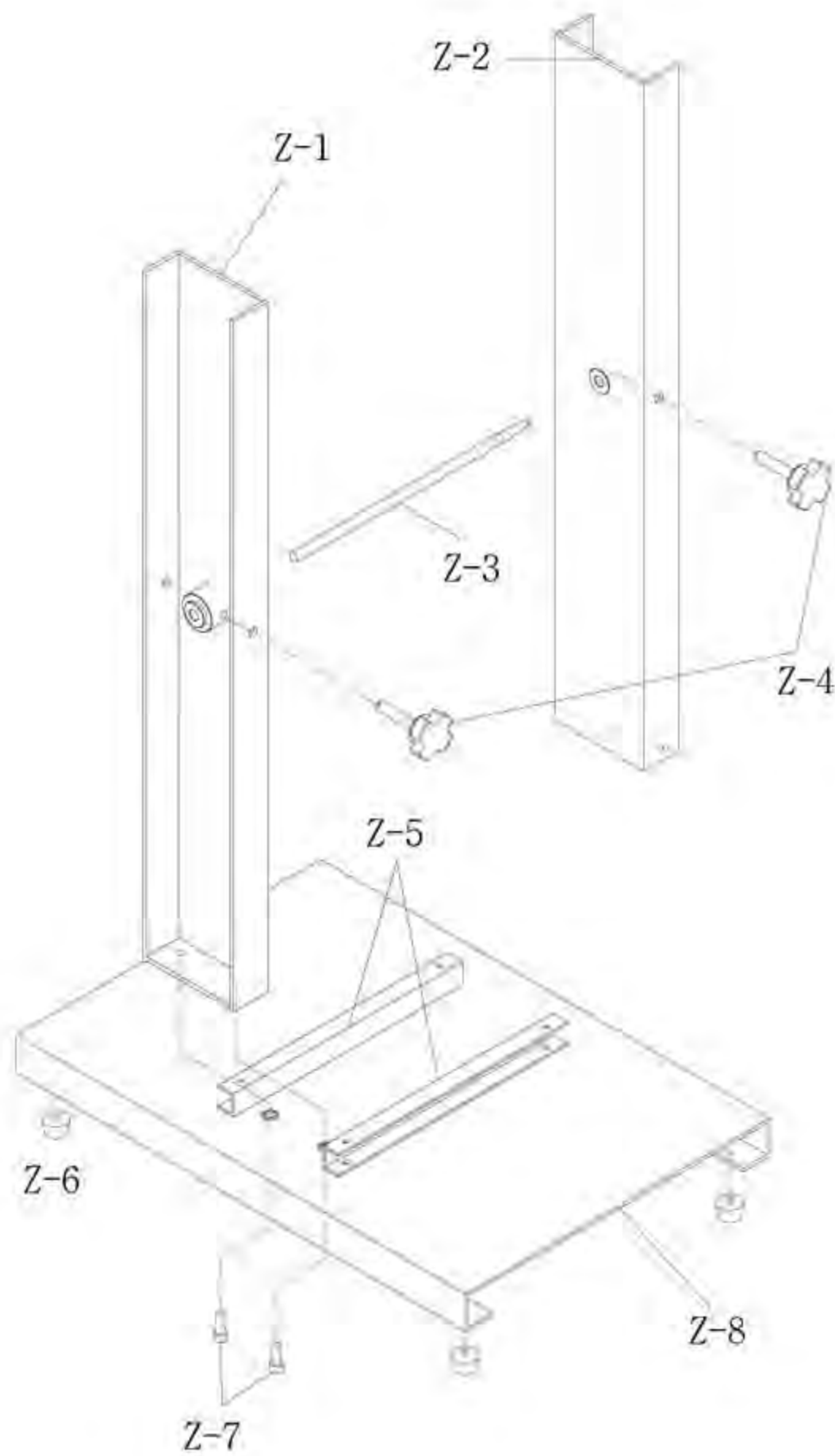

PART NO.	DESCRIPTION	PART NO.	DESCRIPTION
Z-1	ROLL MAIN BARCKET	Z-8	ROLL HANGER BASE
Z-2	ROLL MOVING BRACKET		
Z-3	ROLL CLAMPING SHAFT		
Z-4	ROLL CLAMPING BOLT		
Z-5	ROLL MOVING BRACKET GUIDE		
Z-6	ROLL CLAMPING RUBBER PAD		
Z-7	ROLL CLAMPING BOLT		

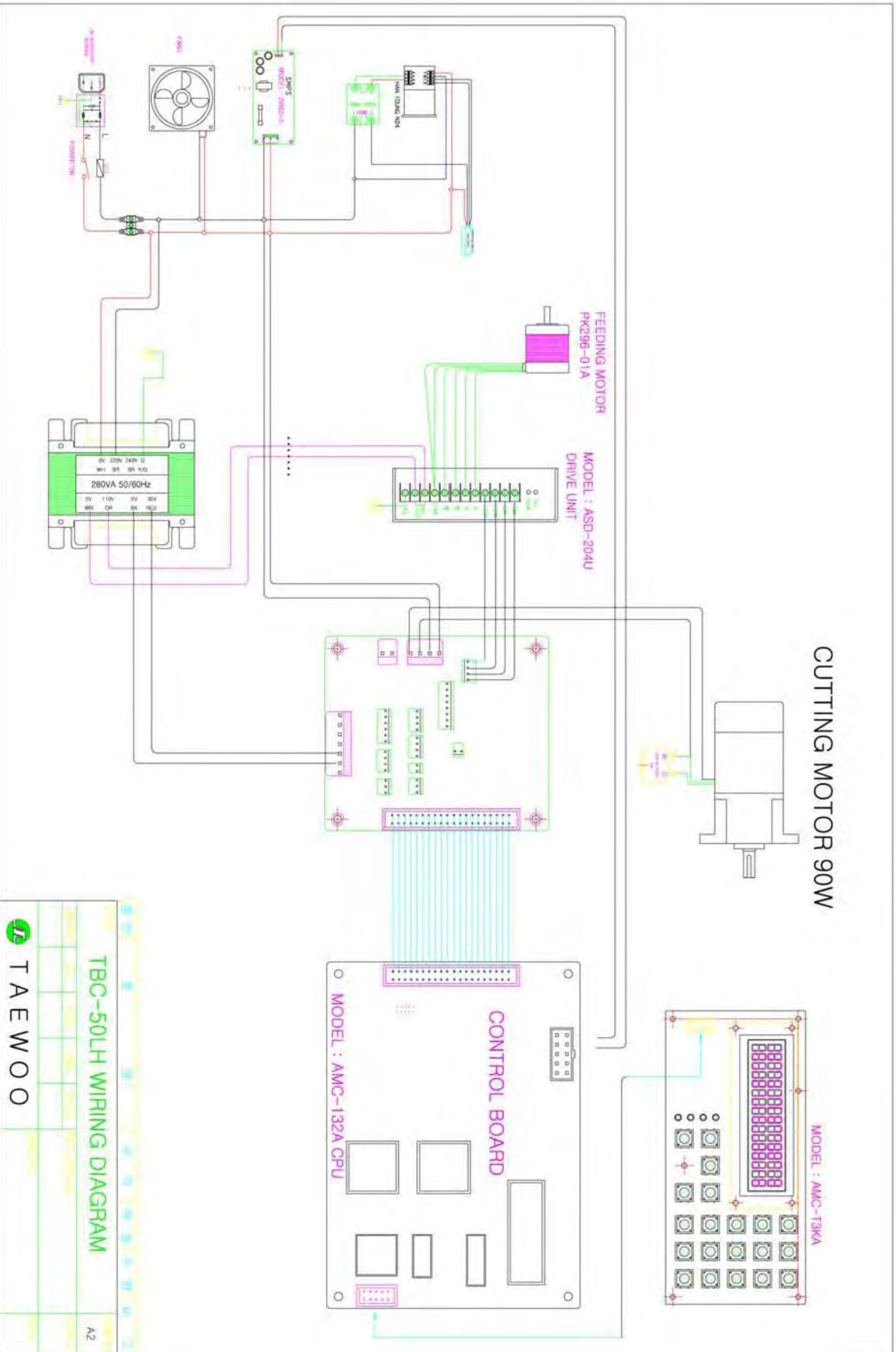

CUTTING MOTOR 90W

TBC-50LH WIRING DIAGRAM
TAEWOO

A2

HOW TO DO AUTO-TUNING

After changing a part or parts (temp. sensor or heater or temp. controller), you can experience that there are much temperature-deviation between set temperature(SV) and present temperature(PV).

In this case, by auto-tuning, you can reduce temperature-deviation between SV and PV.

Please do follow steps for auto-tuning.

- Referring manual, please set your common temperature. (ex, 300°C)
- After PV's reaching set temperature, press “**SET**” and “**△**” simultaneously. (referring to below image(left))
If so, with AT lamp blinks, auto-tuning begins.

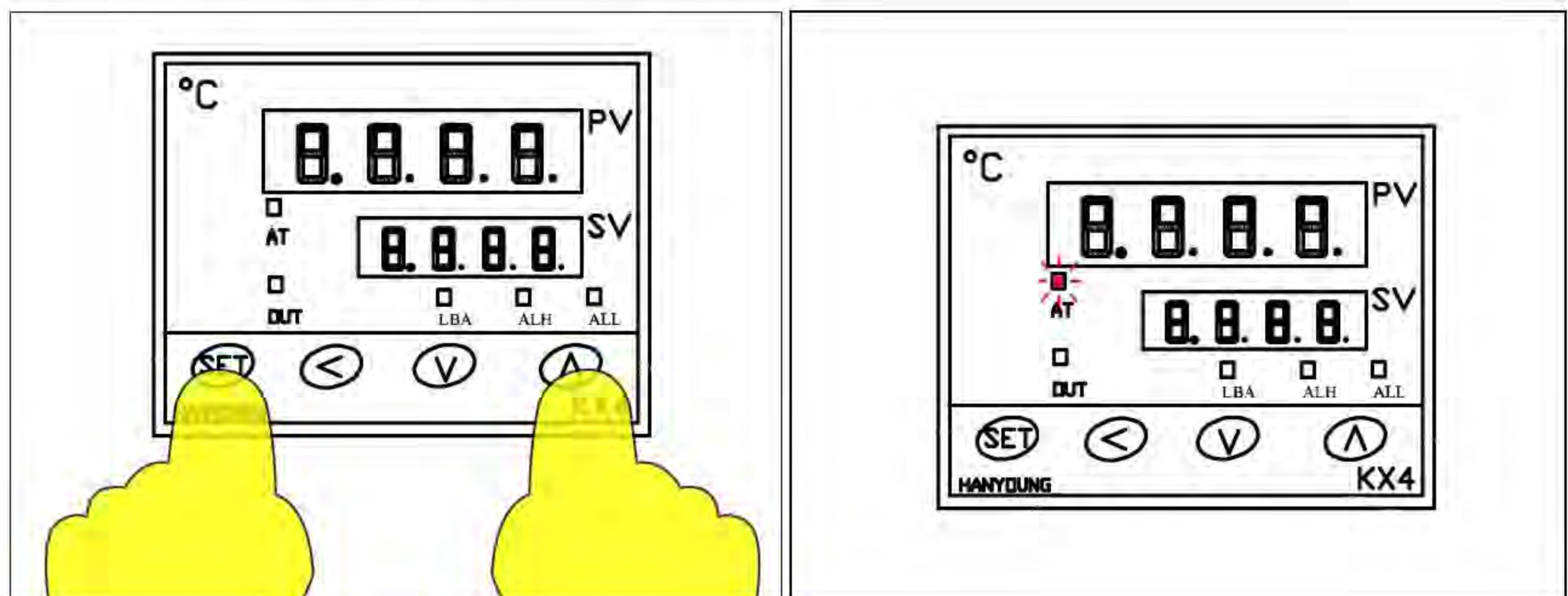

- After finishing auto-tuning, AT lamp will turn off.
- While auto-tuning, if you want to stop auto-tuning, please press “**SET**” and “**△**” simultaneously. If so, AT lamp turns off and auto-tuning stops.
- If you change SV (set temperature) during auto-tuning, auto-tuning stops and temp. controller will use previous parameter.

(How to use Temperature Controller KX4)

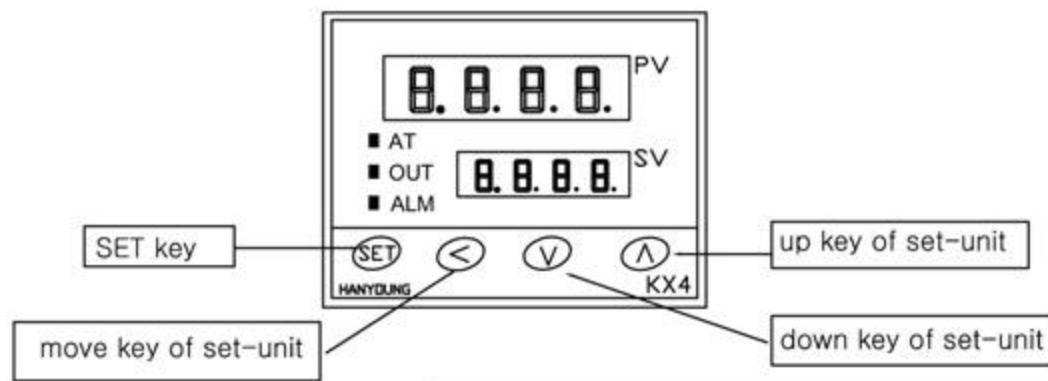

When you power on the controller, PV shows current room temperature and SV shows set temperature. Recommendation is 250°C ~ 350°C. After turn-on & set, within 10 minutes, it reaches to set temperature.

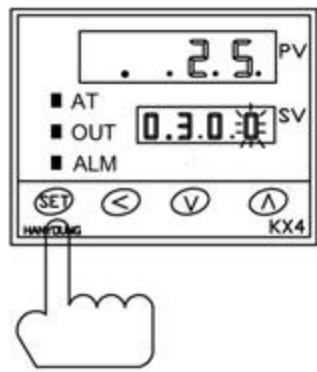

- ① You can enter set mode by pressing **SET** key, you may see one cipher blinks. It means it can be changed.

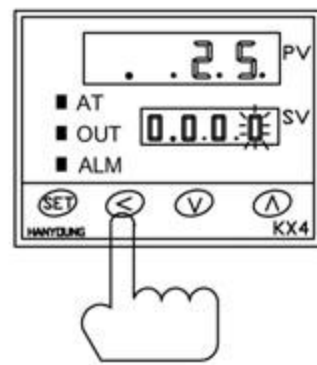

- ② By pressing **<** key, you can move between numbers of four ciphers, as follows.

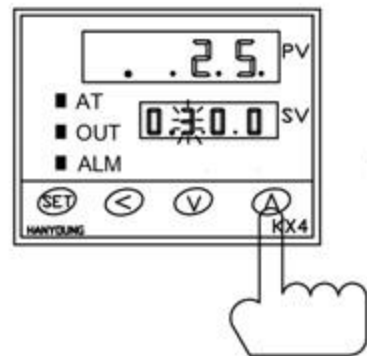
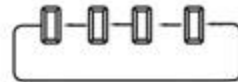

- ③ Set desirous temperature by pressing **>** and **V** keys.(i.e :300°C). Set-temperature will be increased by **>** key and it will decreased by **V** key.

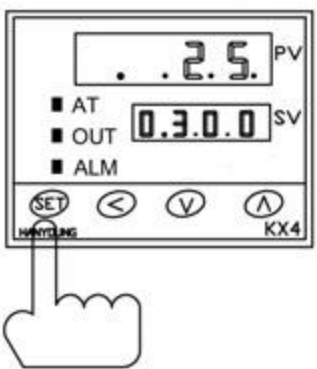

- ④ After finishing setting, press **SET** key once more. Then, it stops blinking. And the controller will return to auto-tuning mode.

CAUTION

At beginning, when you power on, there will be some variation in temperature. But it will be automatically reached to the set temperature soon.

Trouble-shooting of TBC-50 series

No	Troubles		Applicable model	Causes & Measures
1	No power supply		All models	<ul style="list-style-type: none"> - Check if electric cord is connected well. - Check if the fuse blows out or not.
2	Power is on, but no work	Feeding roller doesn't work.	All models	<ul style="list-style-type: none"> - Check if there is inserted any alien substance in roller. - If current length on display is changed, exchange drive board. - If current length on display is not changed, exchange Control board(MB).
		Knife doesn't work.	All models	<ul style="list-style-type: none"> - Check if pressure plates of upper knife are too much fastened or not.
		LCD display doesn't work.	All models	<ul style="list-style-type: none"> - After opening the cover, check the connection. (especially between Operation & MB board)
		All functions don't work	All models	<ul style="list-style-type: none"> - Check if auto-stop device lies down. If any, raise it up.
3	Material is not cut.		Hot cutter (H, LH, SH, HX)	<ul style="list-style-type: none"> - Check if temperature goes up to set-degree. - Check if knife blades are even(parallel).
4	Material is cut onesidedly.		All models	<ul style="list-style-type: none"> - Check if blades are damaged or weared. - After making both knives close each other by M/CUT button and check if they are even or not. (If they are not even, adjust them by bolts)
5	Cut-length is different from set-length.		All models	<ul style="list-style-type: none"> - Test cutting after loosening material from the reel by hand or attaching feeding device.
6	It cuts before the cutting line of labels.		Label cutter (S, SH)	<ul style="list-style-type: none"> - Move the sensor towards knife side as long as the difference by pushing.
7	It cuts after the cutting line of labels.		Label cutter (S, SH)	<ul style="list-style-type: none"> - Move the sensor towards counter-knife side as long as the difference by pushing.
8	ERROR on LCD & LED	ERROR CODE [064] >Sensor check Er	Label cutter (S, SH)	<ul style="list-style-type: none"> - Trouble in Mark sensor → • Check if the sensor is connected well or not. • Check if the sensor is adjusted well or not. (FILE NO 001) • Check if it is label problem or not.
		ERROR CODE [065] >CUT I/O Error!	All models	<ul style="list-style-type: none"> - Trouble in cutting motor or cutting sensor → • Upper knife moves 1~3 sec. and ERROR on display. Check the connection of cutting sensor. If not, exchange the cutting sensor. • Upper knife doesn't move and ERROR on display. Exchange the cutting motor or drive board.
		STOP INPUT !! CHECK STOP INP!	All models	<ul style="list-style-type: none"> - Auto stop device is pressed down or shortage. → raise up the device and check shortage.
		(C)ACORD CTRL-OP AMC-T3KA VER1.7D	All models	<ul style="list-style-type: none"> - Bad connected ROM → Press ROM by hand or connect it again. (If not, change MB board)
		ERROR CODE[065] >CHECK CODE[003]	All models	<ul style="list-style-type: none"> - Change of FILE 003 in program by noise or mis-operation → Initialize the controller. ※ How to Initialize(programs to be initial) : press SET+SHIFT/ESC buttons and RESET button at the same time. (Press RESET later than other two keys.)
9	Operator feels electric current in touch of machine.		All models	<ul style="list-style-type: none"> - Connect the earth cord(green) to any bolt of backside of machine.
10	After exchange ROM, you should do initialize the controller , due to error message, if you cannot do initialization, please press "SHIFT/ESC" button to escape error message screen and then initialize the controller .			



START[®]

I n t e r n a t i o n a l

Please do not disassemble / modify machine or its part without any permission.
If you disassemble / modify machine or its part, you cannot receive warranty/after-sales service.